

JOLLY PLUS 2

CROSS FLOW FAN WITH BRUSHLESS MOTOR



TC PLUS
ON BOARD STEPLESS SPEED CONTROL.
TO BE ORDERED SEPARATELY



UNIT



TC-R Plus

TC-R PLUS
STEPLESS SPEED CONTROL. TO BE ORDERED SEPARATELY.
WALL INSTALLATION



UNIT

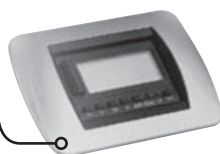

TD-3R

TD-3R
3 SPEED CONTROL. TO BE ORDERED SEPARATELY.
IN-WALL INSTALLATION

> GENERAL FEATURES

Tangential fan coil unit series including high-efficiency brushless motors. 131 mm as maximum depth, attractively designed casing, suitable for residential heating and air conditioning applications. Available in three versions, **VM-F** featuring motorized front air inlet louvre, **VM-G** including fixed inlet grille and **VN** without casing for concealed applications. **Four sizes** and cooling capacity **from 0,83 kW to 3,34 kW**.

The careful design of the main components, refined styling and versatility make them suitable for any type of installation in the residential, commercial or industrial field.

Their installation requires only connection to the electrical and plumbing system

> CONSTRUCTION CHARACTERISTICS

SUPPORTING STRUCTURE: in galvanised high-thickness sheet, integrating structural and functional elements in plastic, such as the condensate tray and fan conveyor.

HEAT EXCHANGE COIL: copper tube arranged in staggered rows in order to increase heat exchange. Aluminium fins, fastened by mechanical expansion of the tubes. The manifolds integrate air vents and water drain holes. The coil has a pocket for the water temperature probe. The fan coils can be ordered with left or right connection. In case of need it is however possible to rotate the coils. Conversion from left to right connection requires nevertheless an adapting kit.

CONDENSATE TRAY: in thermoplastic material -thus corrosion-free- supplied as a standard on models VM-G and VN. It permits either vertical and horizontal installation of the unit.

FAN MOTOR: the motor is a high-efficiency brushless type, speed-controlled. It is fitted on rubber supports to reduce noise transmission to the frame. Speed adjustment occurs on stepless mode. The units are also available on demand with compatibility to Ferroli 3 fixed speed control or pre existing ones.

TANGENTIAL FAN: the tangential-type fan is coupled directly to the motor and mounted on an anti-vibration support.

AIR FILTER: in polypropylene honeycomb, easily removable, it can be regenerated simply by washing with water.

CABINET (only VM-F and VM-G): entirely made in steel sheet and epoxy powder, coated to ensure high corrosion resistance. The air outlet grilles are on the top of the cabinet.

The side panels can be removed to ease the unit's installation and access to its internal components.

Available in colour RAL 9003.

AIR OUTLET GRILLE (only VM-F and VM-G): in aluminium, painted the cabinet colour. It can be rotated to get the air flow towards the room or against the wall.

AIR INLET GRILLE

(*version VM-F*): in extruded aluminium. It includes two thermal actuators opening the grille in parallel with activation of the fan. A microswitch prevents fan operation when the grille is removed for periodic filter cleaning.

(*version VM-G*): also in extruded aluminium. It is mounted below the front panel and is fixed blades type.

Removable for filter cleaning.

PLUMBING CONNECTIONS: the units are equipped with EUROKONUS 3/4" plumbing connections, that allow simple and safe connection.

> CONTROLS

Speed control can be made on progressive mode or on pre-set speeds

STEPLESS SPEED CONTROL

Specific controls - equipped with continuous regulation algorithms - have been developed. Such devices keep steady comfort conditions inside the room. Energy savings are also granted thanks to the fan modulation, as well as sound pressure minimization.

The electronics and its interface are available as on-board version (**TC plus**), for VM-F and VM-G. The unit can be however been ordered without built-in control: a remote one (**TC-R plus**). All controls can be ordered separately as an accessory.

TC-R plus remote thermostat can also handle up to 31 fan-coil units connected together in parallel. This solution is suitable for medium-large rooms containing several installed units.

Functions: Room setpoint regulation / Automatic fan speed / Noise limiter (decreasing fan speed) / NIGHT mode (fan speed decrease / setpoint modification) / MAX (brings speed fan to max)

Connections: 230 V output for ON-OFF valves / Independent voltage-free contacts for activation of a chiller or boiler depending on room thermostat request / Voltage free contact for room presence (window opening contact or hotel badge).

PRE-FIXED SPEED CONTROL

In case a 3 speed-control is wished to be used, **TS PLUS** is fit to be installed as on board thermostat. A interface PCB-**K3V plus** can interact with fan motor. It can be controlled by **TD-R** remote terminal. **The accessory needs to be ordered separately.** Jolly Plus models which are compatible with the mentioned interface can however be coupled with 3-speed thermostats which may be already present in the installation.



INSTALLATION



	<i>Vertical above bearing feet. Room centered or against the wall</i>	<i>Vertical wall-hung</i>	<i>Vertical concealed</i>	<i>Horizontal. Ceiling mounted</i>
VM-F version motorised louvre				
VM-G version fixed louvre				
VN version concealed				

TECHNICAL DATA



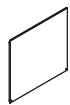

MODEL		20	40	60	80
PERFORMANCE					
Total cooling capacity	W	830	1760	2650	3340
Sensible cooling capacity	W	620	1270	1960	2650
Water flow rate	l/h	143	303	456	574
Water pressure loss	kPa	7,2	8,4	22,5	18,6
Heating capacity at 50°C inlet water	kW	1090	2350	3190	4100
Water flow rate (50°C inlet water)	l/h	142	302	453	573
Water pressure loss (50°C inlet water)	KPa	5,7	6,6	16,3	14,0
Heating capacity without fan (50°C)	W	210	247	291	366
Heating capacity at 70°C inlet water ΔT 10	kW	1890	3990	5470	6980
Water flow rate (70°C ΔT 10)	l/h	162	343	471	600
Water pressure loss (70°C ΔT 10)	kPa	6,7	7,6	16,1	14,0
Heating capacity without fan (70°C)		322	379	447	563
HYDRAULIC CHARACTERISTICS					
Coil water content	litres	0,47	0,8	1,13	1,46
Max. operating pressure	bar	10	10	10	10
Plumbing connections	inches	Eurokonus 3/4	Eurokonus 3/4	Eurokonus 3/4	Eurokonus 3/4
AERAILIC DATA					
Max. air flow	m3/h	162	320	461	576
Air flow at medium speed (AUTO mode)	m3/h	113	252	367	453
Air flow at min. fan speed	m3/h	55	155	248	370
Available max. static pressure	Pa	10	10	13	13
ELECTRICAL DATA					
Power supply voltage	V/ph/Hz	230/1/50	230/1/50	230/1/50	230/1/50
Max. power absorbed	W	12	18	20	26
Max. current absorbed	A	0,11	0,16	0,18	0,26
Power absorbed at min. speed	W	4	5	5	6
SOUND LEVEL					
Sound pressure at max. air flow	dB(A)	39,4	40,2	42,2	42,5
Sound pressure at medium air flow	dB(A)	33,2	34,1	34,4	35
Sound pressure at min. air flow	dB(A)	24,2	25,3	25,6	26,3
WEIGHT					
Net weight unit VM-F / VM-G	kg	17	20	23	26
Net weight unit VN	kg	9	12	15	18
CODE (see page 3)	VM-G	2C027M5F	2C027W5F	2C027Y5F	2C027I5F
	VM-F	2C02725F	2C02785F	2C027E5F	2C027L5F
	VN	2C02705F	2C02765F	2C027C5F	2C027J5F

ACCESSORIES

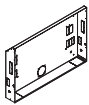

REMOTE CONTROL							
MODEL		DESCRIPTION	20	40	60	80	CODE
TC PLUS	-	On board stepless, speed controller and thermostat	•	•	•	•	2C0276YF
CC-R PLUS	-	Remote stepless, speed controller and thermostat	•	•	•	•	2C0274YF
TC-R PLUS		Remote user interface - continuous control thermostat	•	•	•	•	2C0275YF
TS PLUS	-	On board basic thermostat	•	•	•	•	2C027BYF
K3V PLUS	-	3 speed kit	•	•	•	•	2C0277YF
TD-3R		Remote digital user interface - 3 speed control	•	•	•	•	2C0211YF

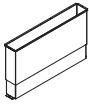
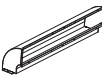
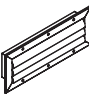
INSTALLATION ACCESSORIES							
VM-F / VM-G version							
MODEL		DESCRIPTION	20	40	60	80	CODE
PC 20		Front closing panel mod VM-F / VM-G 20	•				2C0270XF
PC 40		Front closing panel mod VM-F / VM-G 40		•			2C0271XF
PC 60		Front closing panel mod VM-F / VM-G 60				•	2C0272XF
PC 80		Front closing panel mod VM-F / VM-G 80					•
PE		Cover feet (for wall-hung installation)	•	•	•	•	2C0278XF
PA		Bearing feet	•	•	•	•	2C0279XF

ACCESSORIES FOR VM-G HORIZONTAL INSTALLATION							
BO 20		Pan for horizontal installation mod. VM-G 20	•				2C0214XF
BO 40		Pan for horizontal installation mod. VM-G 40		•			2C0215XF
BO 60		Pan for horizontal installation mod. VM-G 60				•	2C0216XF
BO 80		Pan for horizontal installation mod. VM-G 80					•

VN version							
MODEL		DESCRIPTION	20	40	60	80	CODE
CF 20		Formwork mod VN 20	•				2C021LWF
CF 40		Formwork mod VN 40		•			2C021MWF
CF 60		Formwork mod VN 60				•	2C021NWF
CF 80		Formwork mod VN 80					•
PCF 20		Cover panel mod VN 20	•				2C021QWF
PCF 40		Cover panel mod VN 40		•			2C021RWF
PCF 60		Cover panel mod VN 60				•	2C021SWF
PCF 80		Cover panel mod VN 80					•
RA 20		Air intake fitting mod VN 20	•				2C0210WF
RA 40		Air intake fitting mod VN 40		•			2C0211WF
RA 60		Air intake fitting mod VN 60				•	2C0212WF
RA 80		Air intake fitting mod VN 80					•
PMT 20		Flow telescopic plenum mod VN 20	•				2C0214WF
PMT 40		Flow telescopic plenum mod VN 40		•			2C0215WF
PMT 60		Flow telescopic plenum mod VN 60				•	2C0216WF
PMT 80		Flow telescopic plenum mod VN 80					•
PMP 20		Flow perpendicular plenum mod VN 20	•				2C0218WF
PMP 40		Flow perpendicular plenum mod VN 40		•			2C0219WF
PMP 60		Flow perpendicular plenum mod VN 60				•	2C021AWF
PMP 80		Flow perpendicular plenum mod VN 80					•
GM 20		Flow grille-curved blades mod VN 20	•				2C021CWF
GM 40		Flow grille-curved blades mod VN 40		•			2C021DWF
GM 60		Flow grille-curved blades mod VN 60				•	2C021EWF
GM 80		Flow grille-curved blades mod VN 80					•
GA 20		Intake grille-curved blades mod VN 20	•				2C021GWF
GA 40		Intake grille-curved blades mod VN 40		•			2C021HWF
GA 60		Intake grille-curved blades mod VN 60				•	2C021JWF
GA 80		Intake grille-curved blades mod VN 80					•

ACCESSORIES

HYDRAULIC ACCESSORIES							
MODEL		DESCRIPTION	20	40	60	80	CODE
VB 2		2-way valve	•	•	•	•	2C0212YF
VB 3		3-way valve	•	•	•	•	2C0213YF
KRE 3/4"	-	Conversion kit Eurokonus 3/4" F	•	•	•	•	2C0219YF
KRE 1/2"	-	Conversion kit Eurokonus 1/2" F	•	•	•	•	2C021AYF
KLR PLUS	-	Water connection conversion left to right	•	•	•	•	2C0238YF

DIMENSIONS

VM-F e VM-G version



VN version

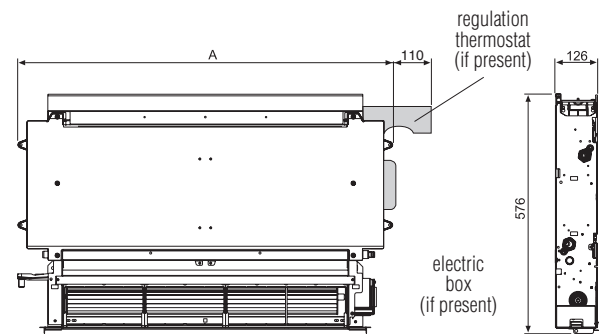

MODEL	20	40	60	80
VM-F / VM-G (mm)	735	935	1135	1335
VN (mm)	479	679	879	1079